

## WFB 20-12 D3/16"

### Technical data

TH accessories category

WFB 20-12

Mounting

D3/16"

Quick change inserts

Boring tool holder

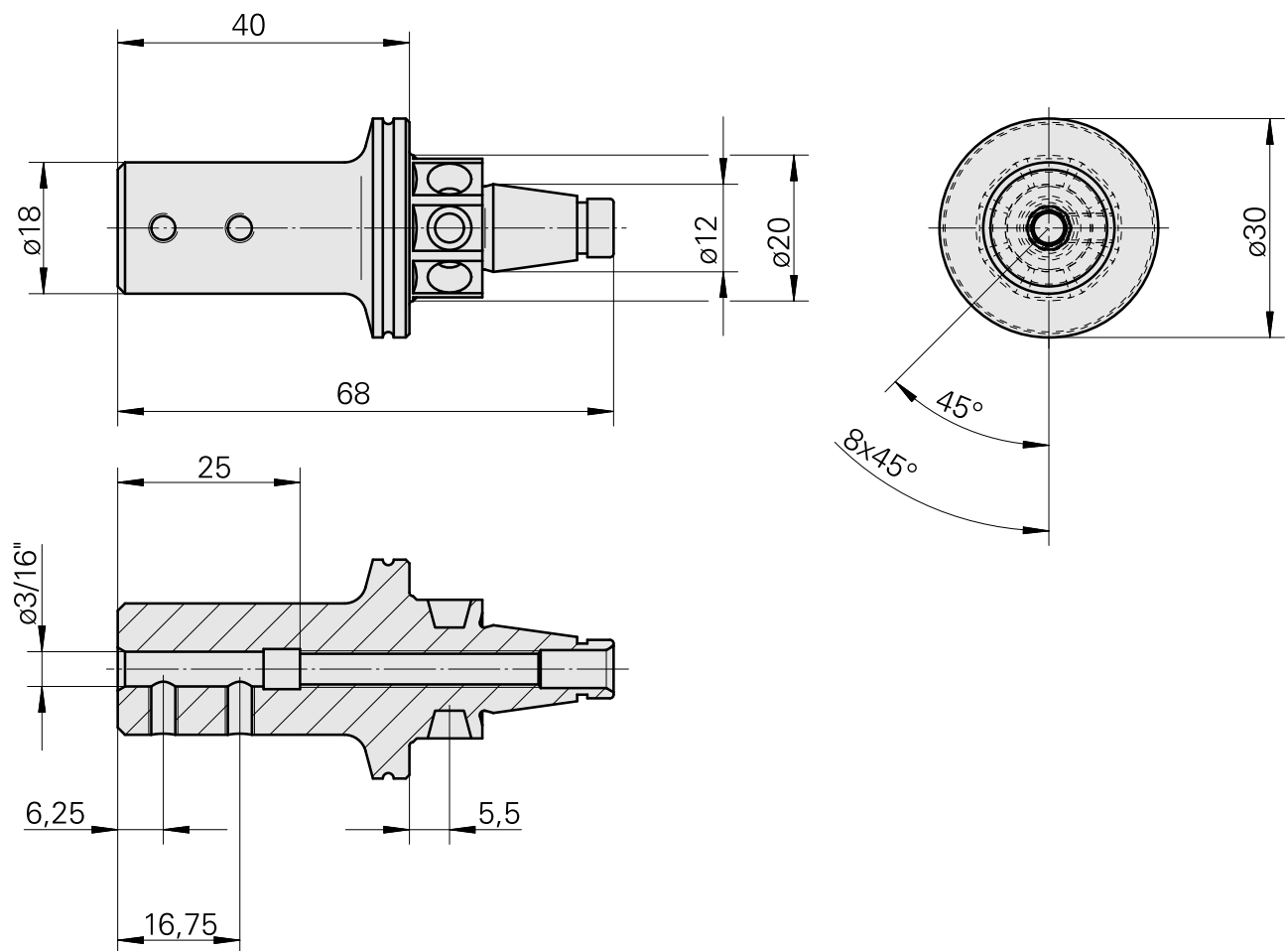
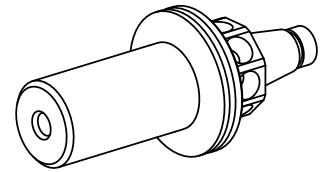

## Documents

No downloads available for this product

## Accessories

Optional accessories

### Other accessories

#### [Adjusting screw M 5x15](#)

Product ID : 10491071

Previous product ID : 326794

---

#### [Grub screw](#)

Product ID : 10039648

Previous product ID : 410156.0405

---