

Porte-foret D8

Données techniques

Entraînement	non entraîné
Fixation MS	Bague de serrage D28,5
Arrosage	central
Pression	80 bar
Attachement	D8
X [mm]	-
Y [mm]	-
Z [mm]	-
Produits INDEX TRAUB	A100 • MS16-6 • MS22-6 • MS22-8 • MS24-6 • MS16-6 Plus

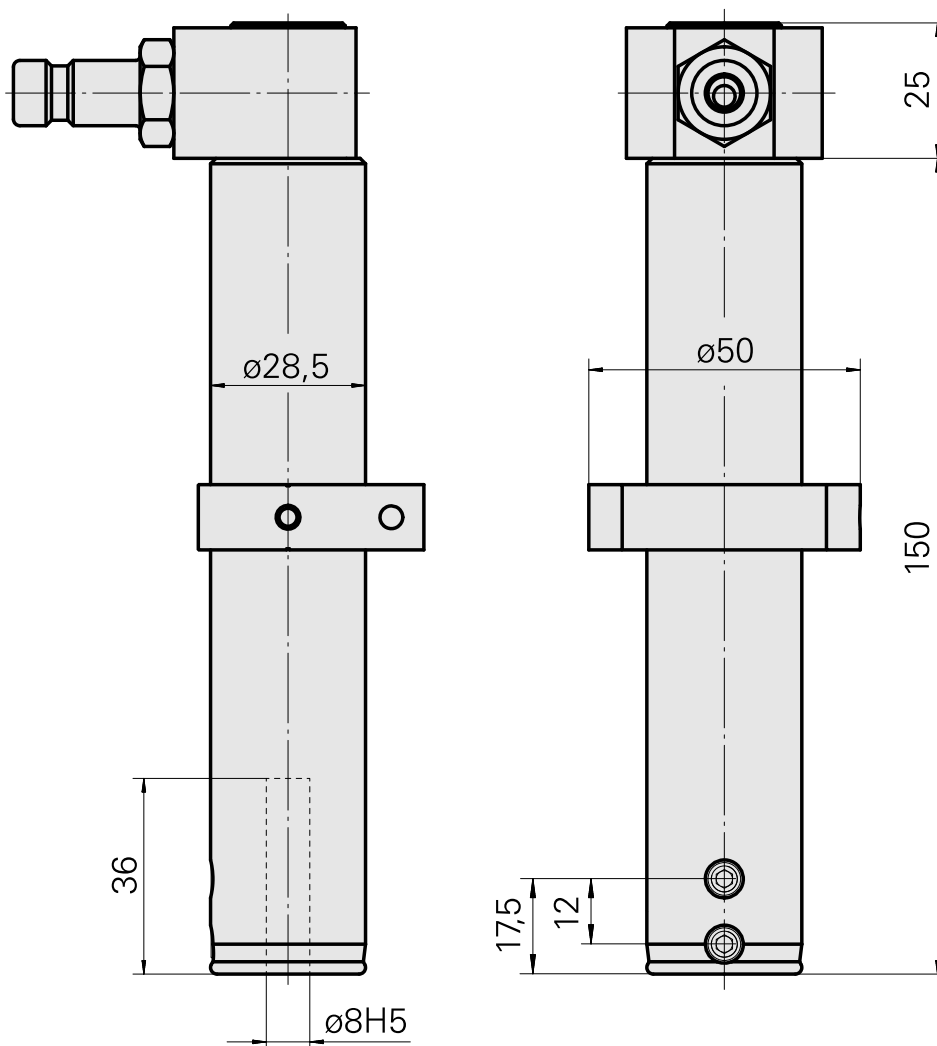

Documents

Aucun téléchargement n'est disponible pour ce produit

Accessoires

Accessoires optionnels

Autres accessoires

[Embrayage SP-006-0-WR513-11-2 Serie LP](#)

ID produit : 10837142

Ancienne ID produit : 474940.0112

[Nipple SP-006-1-WR013-11 Serie LP](#)

ID produit : 10186287

Ancienne ID produit : 474946.25
