

Saw blade, circular saw blade width 1.6 mm (0.06")

Technical data

TH accessories category

Circular saw blade d125

Tool mounting

22mm

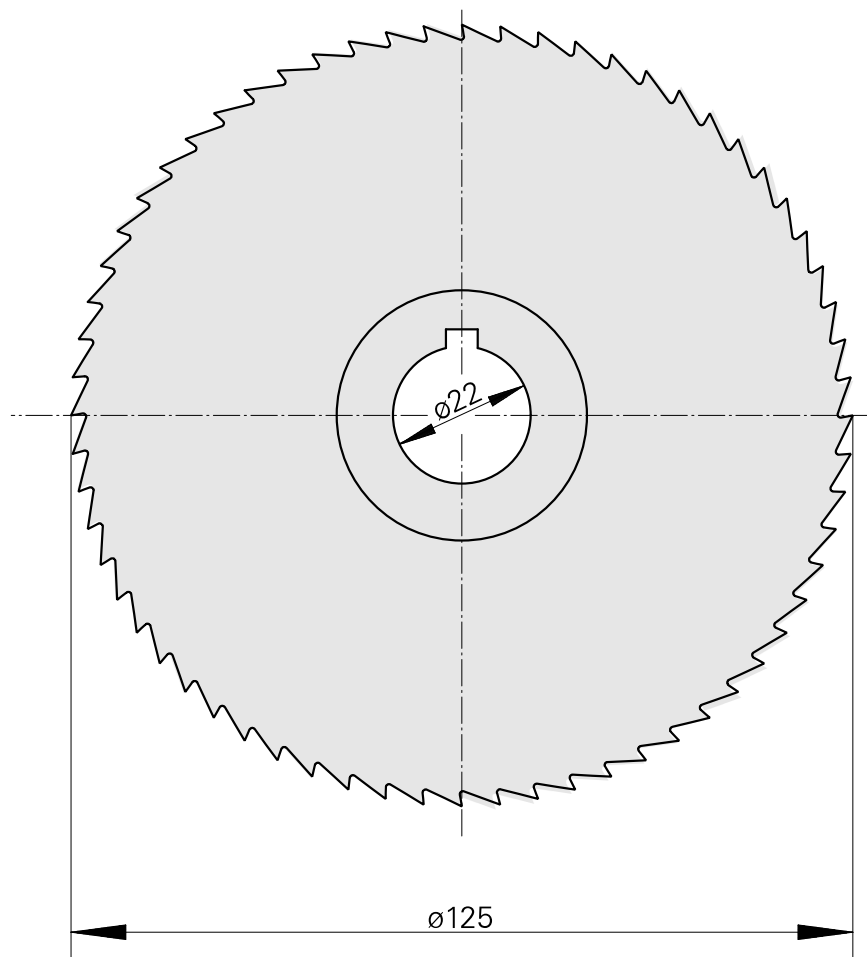

Documents

No downloads available for this product