

Ponta cortante (broca) para DN.. 1506..

Características técnicas

Recepção	para DN.. 1506..
Refrigeração	interno
Pressão (até)	50 bar
X [mm]	36
Z [mm]	35
Produtos INDEX TRAUB	G420 • G520 • G320.2 • G220.3 • TNX220.3

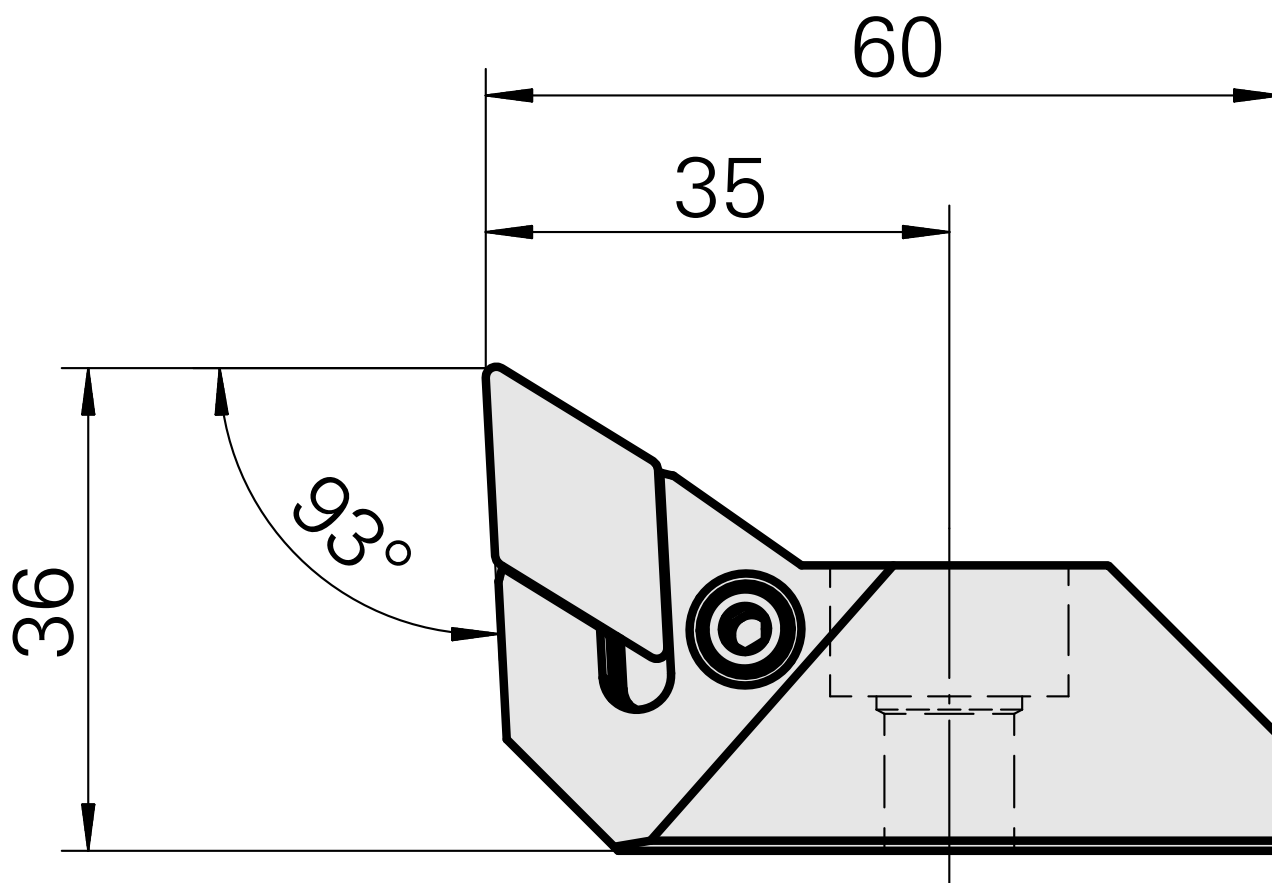
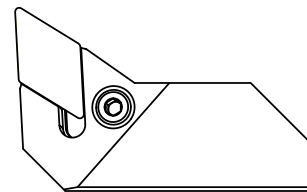

Documentos

Não há downloads disponíveis para este produto