

Drilling tool holder VDI 20 D12, Form E2

Technical data

Shank VDI	VDI 20
Drive	not live
Fixation VDI	none
Cooling	external
Pressure	20 bar
Mounting	D12
reversible 180°	no
X [mm]	50 (1.97")
Y [mm]	-
Z [mm]	-

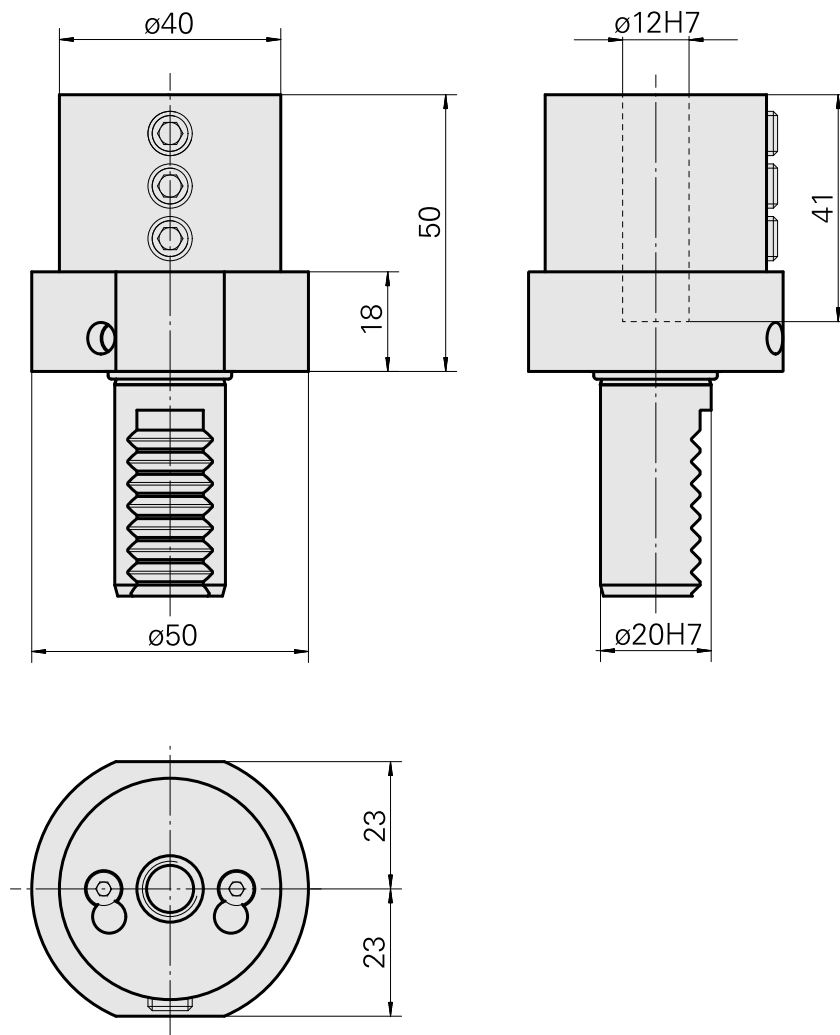

Documents

No downloads available for this product

Accessories

Optional accessories

Other accessories

[Mounting sleeve with collar D12](#)

Product ID : 11060576

Previous product ID : W94280.21--
