

## Adap. auxílio montagem VDI 30

### Características técnicas

PF Categoria de acessórios

Adap. auxílio montagem

Alojamento de ferramenta

VDI 30

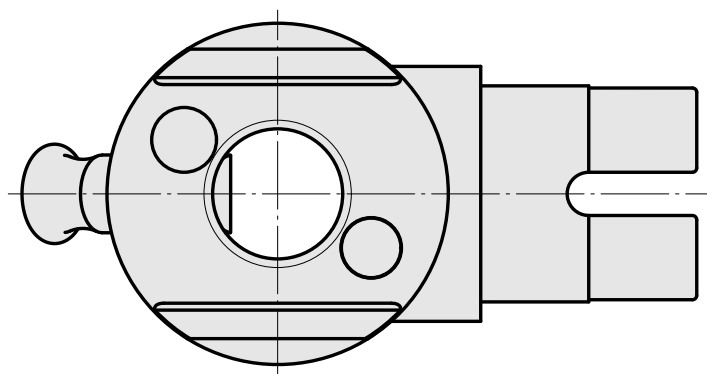
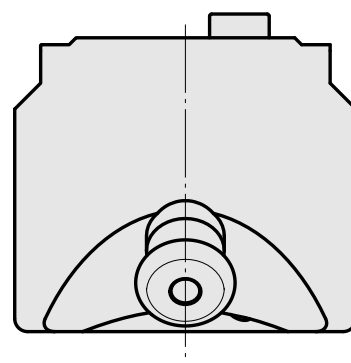
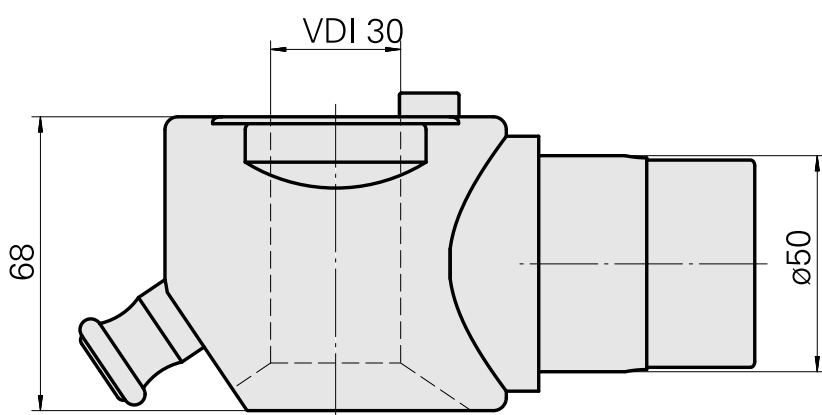
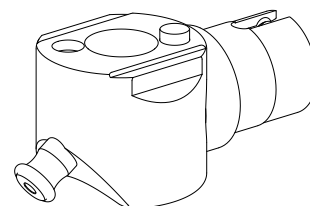

## **Documentos**

Não há downloads disponíveis para este produto