

## Drilling tool holder Shank 40 D20 (0.79)

### Technical data

Shank TNL	Shank 40
Drive	not live
Cooling	internal
Pressure	120 bar
Mounting	D20
INDEX TRAUB products	TNK36 • TNL26

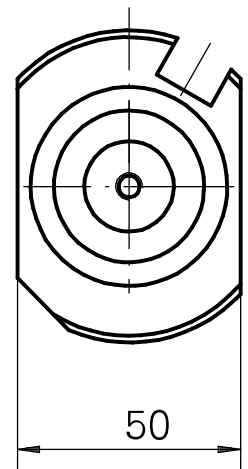
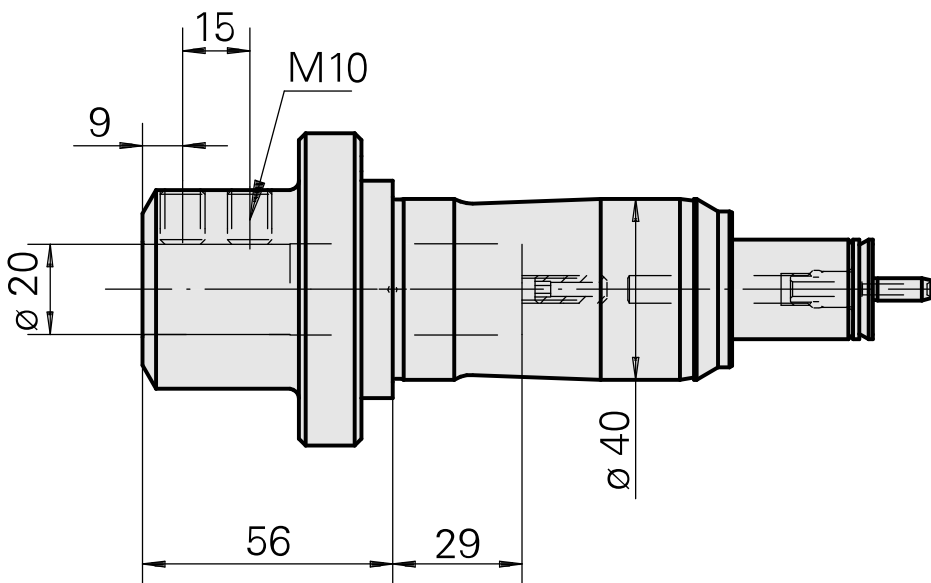
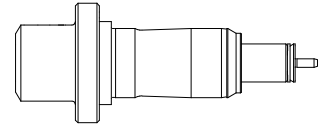

10050392  
984511

**INDEX**

---

## **Documents**

No downloads available for this product