

## Voreinst. SK50/WFB 24-16

### Technische Daten

WZH Zubehörkategorie

Adapter für Voreinstellgeräte

Aufnahme

SK50 für Voreinstellgeräte

Werkzeugaufnahme

WFB 24-16

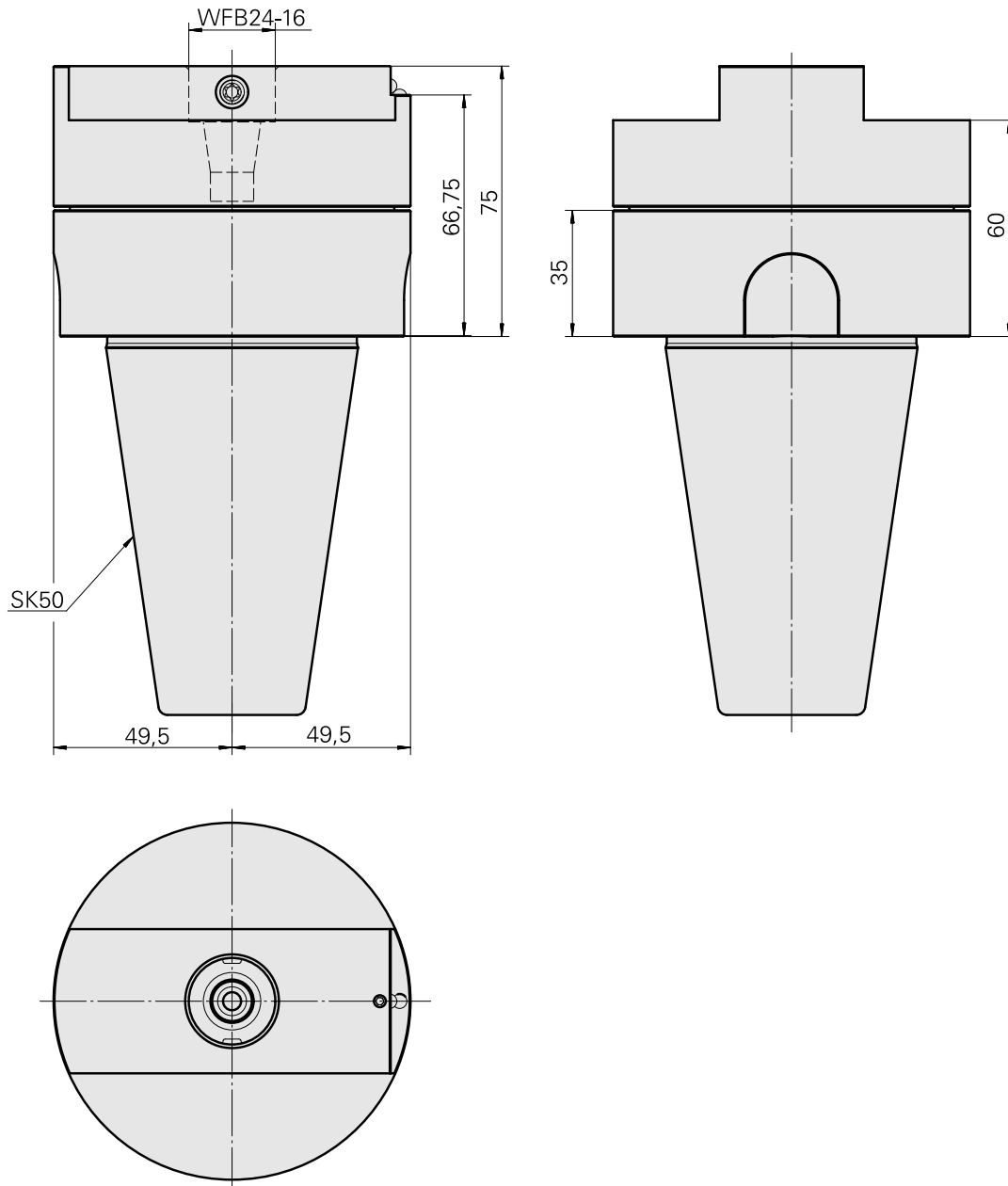
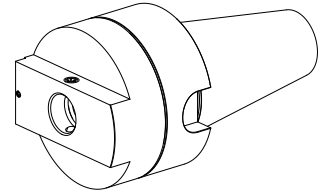

## **Dokumente**

Für dieses Produkt sind keine Downloads vorhanden