

## WFB 32-20 D25

### Technical data

|                         |                 |
|-------------------------|-----------------|
| TH accessories category | WFB 32-20       |
| Mounting                | D25             |
| Quick change inserts    | Weldon mounting |

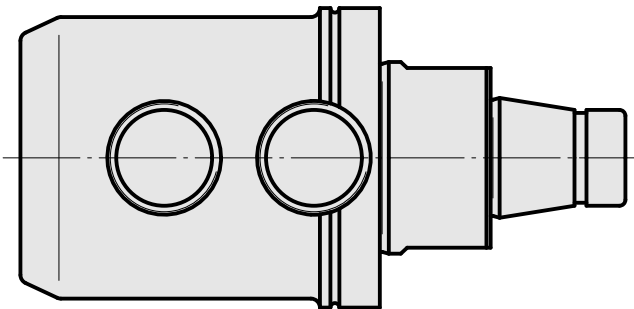
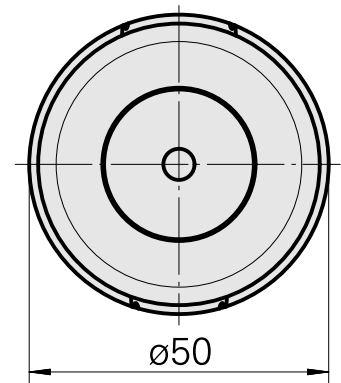
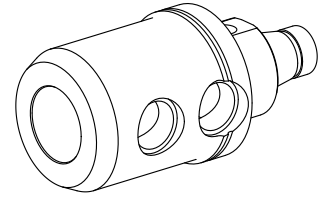

## **Documents**

No downloads available for this product

## **Accessories**

Optional accessories

### **Other accessories**

[Mounting sleeve with collar D25](#)

Product ID : 10070544

Previous product ID : W62221.41--

---