

## ER-Collet chuck for taps ET 1-20 5mm

### Technical data

TH accessories category	ER-Collet chuck for taps
Mounting	ER20
Tool mounting	5mm
Collet type	ET 1-20

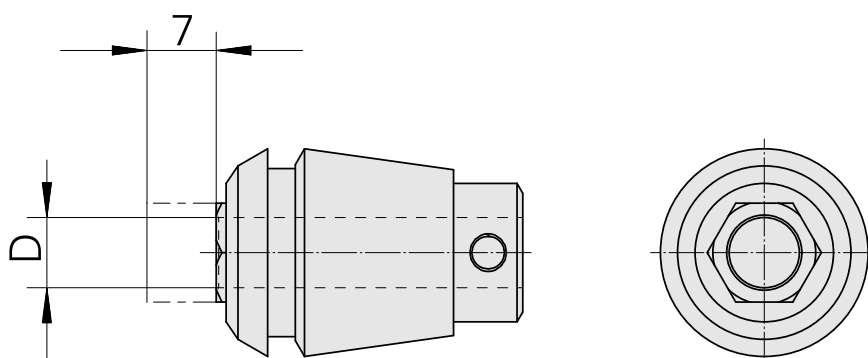
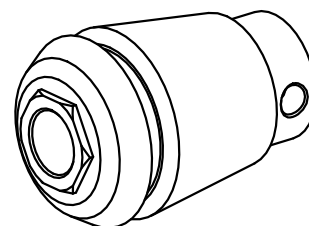

10767883  
323446

**INDEX**

---

## **Documents**

No downloads available for this product