

METALLKREISSÄGEBLATT, Breite Kreisägeblattes 2,5 mm

Technische Daten

WZH Zubehörkategorie

Kreissägeblatt D63

Werkzeugaufnahme

16mm

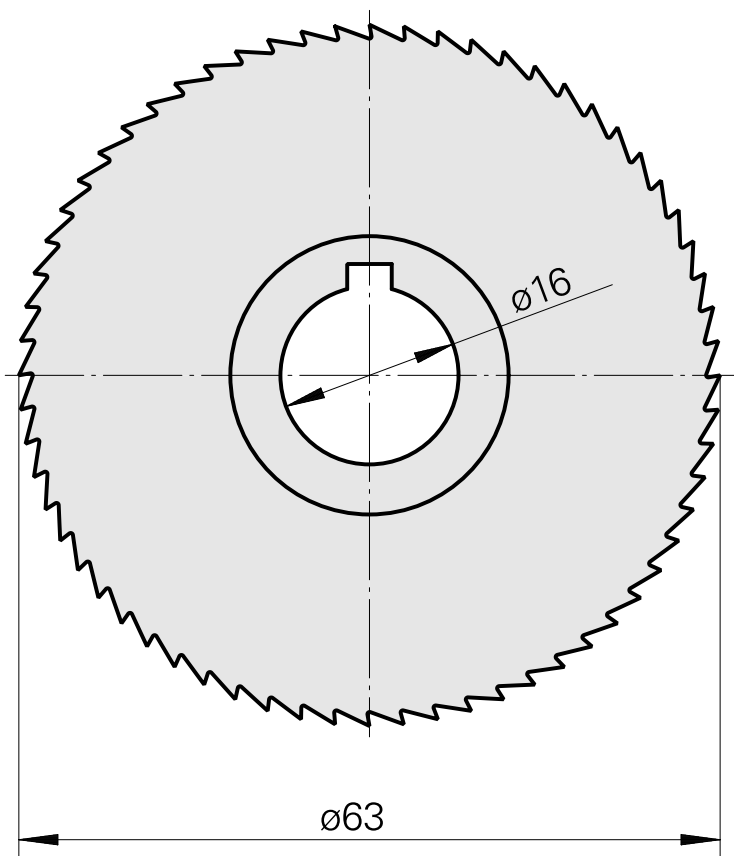

Dokumente

Für dieses Produkt sind keine Downloads vorhanden